



# Digitalna tehnika

## 3. poglavje:

Logične funkcije in  
osnovna digitalna vezja



# Tri osnovne Boolove funkcije nad logičnimi spremenljivkami

## disjunkcija

logični ali (+,  $\vee$ )

Izjavna tabela:

$x_1$	$x_2$	$y$
0	0	0
0	1	1
1	0	1
1	1	1

Lastnosti disjunkcije:

$$A + 0 = A$$

$$A + 1 = 1$$

$$A + A = A$$

$$A + \overline{A} = 1$$

## konjunkcija

logični in ( $\cdot$ ,  $\wedge$ ,  $\&$ , brez znaka)

Izjavna tabela:

$x_1$	$x_2$	$y$
0	0	0
0	1	0
1	0	0
1	1	1

Lastnosti konjunkcije:

$$A \cdot 0 = 0$$

$$A \cdot 1 = A$$

$$A \cdot A = A$$

$$A \cdot \overline{A} = 0$$

## negacija

logični ne (črta nad spremenljivko  
ali izrazom,  $\backslash$ ,  $\neg$ )

Izjavna tabela:

$x$	$y$
0	1
1	0



# Postulati (aksiomi) in teoremi

	<i>Postulati (aksiomi)</i>		<i>Teoremi(izreki)</i>
1	$X + 0 = X$	1	$X + 1 = 1$
1'	$X \cdot 1 = X$	2	$X + X = X$
2	$X + Y = Y + X$	3	$X \cdot X = X$
2'	$X \cdot Y = Y \cdot X$	4	$\overline{\overline{X}} = X$
3	$X + (Y \cdot Z) = X + Y \cdot Z =$ $= (X + Y) \cdot (X + Z)$	5	$X \cdot 0 = 0$
3'	$X \cdot (Y + Z) = X \cdot Y + X \cdot Z$	6	$X + XY = X$
4	$X + \overline{X} = 1$	7	$X \cdot (X + Y) = X$
4'	$X \cdot \overline{X} = 0$	8	$(X + \overline{Y}) \cdot Y = XY$
		9	$X \cdot \overline{Y} + Y = X + Y$
		10	$(X + Y) + \overline{X} = 1$
		11	$(\overline{X} \cdot \overline{Y}) \cdot X = 0$
		12	$\overline{X + Y} = \overline{X} \cdot \overline{Y}$ ( <i>de Morgan</i> )
		13	$\overline{X \cdot Y} = \overline{X} + \overline{Y}$ ( <i>de Morgan</i> )



# Postulati (aksiomi) in teoremi

Primer:

$$\begin{aligned} Y &= (AB(C + D + E) + DBA) \cdot (\overline{A} + \overline{B} + \overline{E}) \\ &= (\underline{AB(C + D + E)} + DBA) \cdot (\overline{A} + \overline{B} + \overline{E}) \\ &= (ABC + \underline{ABD} + ABE + \underline{DBA}) \cdot (\overline{A} + \overline{B} + \overline{E}) \\ &= (ABC + ABD + ABE) \cdot (\overline{A} + \overline{B} + \overline{E}) \\ &= (ABC + ABD + ABE) \cdot \overline{ABE} \\ &= ABC\overline{ABE} + ABD\overline{ABE} + \underline{ABE\overline{ABE}} \\ &= ABC\overline{ABE} + ABD\overline{ABE} \\ &= AB(C + D)\overline{ABE} \\ &= AB(C + D)(\overline{AB} + \overline{E}) \\ &= \underline{AB(C + D)\overline{AB}} + AB(C + D)\overline{E} \\ &= AB\overline{E}(C + D) = ABC\overline{E} + ABDE \end{aligned}$$



# Izvedba Boolovih funkcij s stikali

Logični in

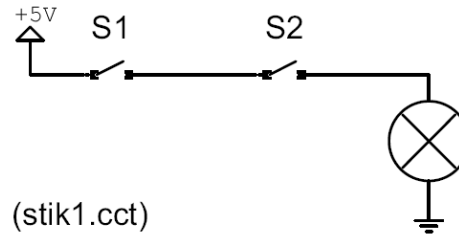

$$S_1 \cdot S_2$$

Logični ali

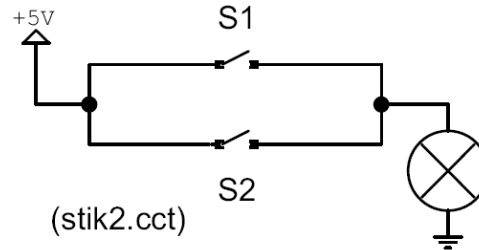

$$S_1 + S_2$$



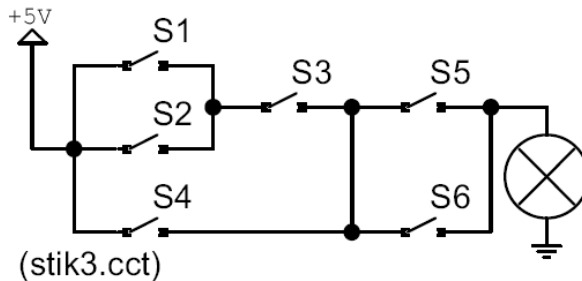



Primeri:

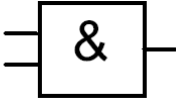

$$(S_1 \cdot S_2 + S_3 \cdot S_4) \cdot S_5 + S_6$$

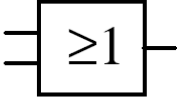

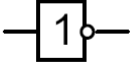
# Osnovna logična vrata

	Simbol po IEC standardu	Simbol po ANSI standardu
<b>IN (AND)</b>		
<b>ALI (OR)</b>		
<b>NE (NOT, inverter)</b>		



# Osnovna logična vrata

Primeri:

(log1.cct)

$$Y = A \cdot \bar{B} + B \cdot C$$

Izjavna tabela:

A	B	C	Y
0	0	0	0
0	0	1	0
0	1	0	0
0	1	1	1
1	0	0	1
1	0	1	1
1	1	0	0
1	1	1	1

(log2.cct)

$$Y = \bar{A} \cdot B \cdot C + \bar{B} \cdot \bar{C}$$

Izjavna tabela:

A	B	C	Y
0	0	0	1
0	0	1	0
0	1	0	0
0	1	1	1
1	0	0	1
1	0	1	0
1	1	0	0
1	1	1	0



# Druga logična vrata

**NE IN (NAND)**

Shefferjeva funkcija

$$y = \overline{x_1 \cdot x_2}$$

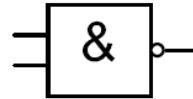

Karakteristična tabela:

$x_1$	$x_2$	$y$
0	0	1
0	1	1
1	0	1
1	1	0

**NE OR (NOR)**

Pierceova funkcija

$$y = \overline{x_1 + x_2}$$

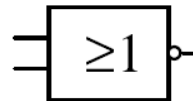

Karakteristična tabela:

$x_1$	$x_2$	$y$
0	0	1
0	1	0
1	0	0
1	1	0





# Druga logična vrata

## Ekskluzivna ALI

EXOR funkcija  
antivalenca

$$y = x_1 \oplus x_2$$

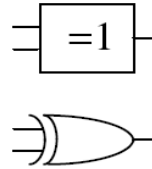

Karakteristična tabela:

$x_1$	$x_2$	$y$
0	0	0
0	1	1
1	0	1
1	1	0

izvedba z osnovnimi vrati  
(iz karakteristične tabele:)

$$Y = \bar{A}B + A\bar{B}$$

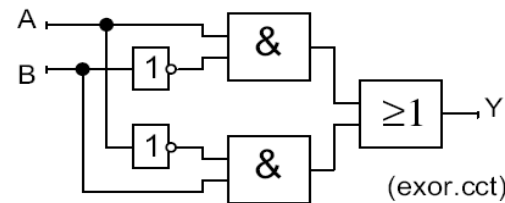

Karakteristična tabela:

$x_1$	$x_2$	$x_3$	$y$
0	0	0	0
0	0	1	1
0	1	0	1
0	1	1	0
1	0	0	1
1	0	1	0
1	1	0	0
1	1	1	1

## Večvhodna EXOR vrata:

Liho število enic na vhodih da enico na izhodu.

Primer uporabe: generator sode paritete

Če je na vhodu liho število enic, bo izhod 1, sicer pa bo 0.



# Druga logična vrata

## **Ekskluzivna NE ALI**

EX NOR funkcija  
ekvivalenca

$$y = \overline{x_1 \oplus x_2}$$

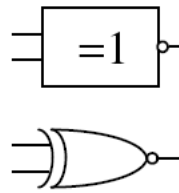

Karakteristična tabela:

$x_1$	$x_2$	$y$
0	0	1
0	1	0
1	0	0
1	1	1

izvedba z osnovnimi vrati  
(iz karakteristične tabele:)

$$Y = AB + \overline{A}\overline{B}$$

ali po de Morganu:  
 $Y = AB + \overline{A + B}$

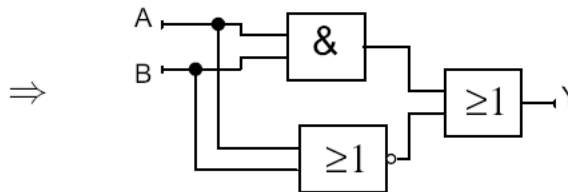
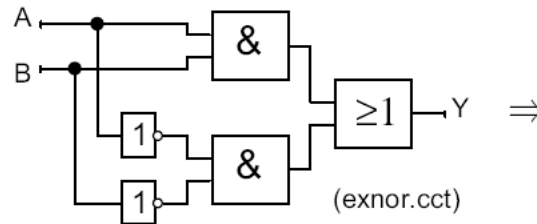

# Izvedba vezij z NAND vrati

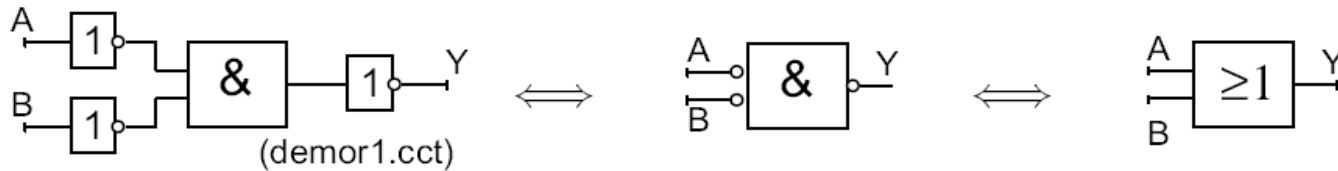

Po de Morgani ( $\overline{A \cdot B} = \overline{A} + \overline{B}$ ):

$$\overline{\overline{A \cdot B}} = \overline{\overline{A} + \overline{B}} \Rightarrow \overline{\overline{A} \cdot \overline{B}} = A + B$$

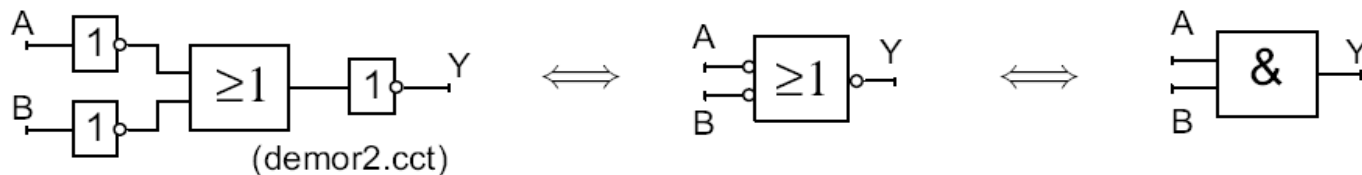

Po de Morgani ( $\overline{A + B} = \overline{A} \cdot \overline{B}$ ):

$$\overline{\overline{A + B}} = \overline{\overline{A} \cdot \overline{B}} \Rightarrow \overline{\overline{A} + \overline{B}} = A \cdot B$$



# Kanonične oblike, mintermi, makstermi

A	B	C	Y
0	0	0	0
0	0	1	1
0	1	0	0
0	1	1	0
1	0	0	0
1	0	1	0
1	1	0	0
1	1	1	1

$$Y = \overline{A}\overline{B}C + ABC$$

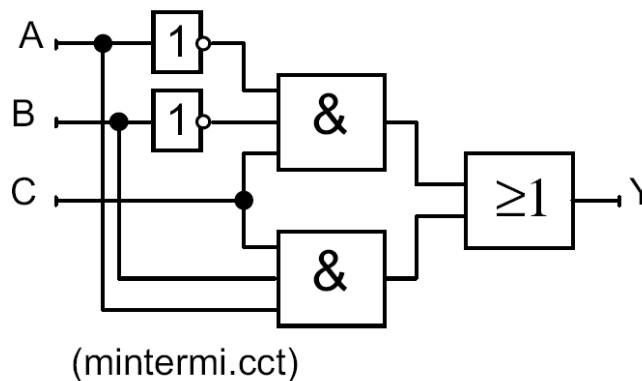

# Minimizacija Boolovih funkcij

Vennovi diagrami

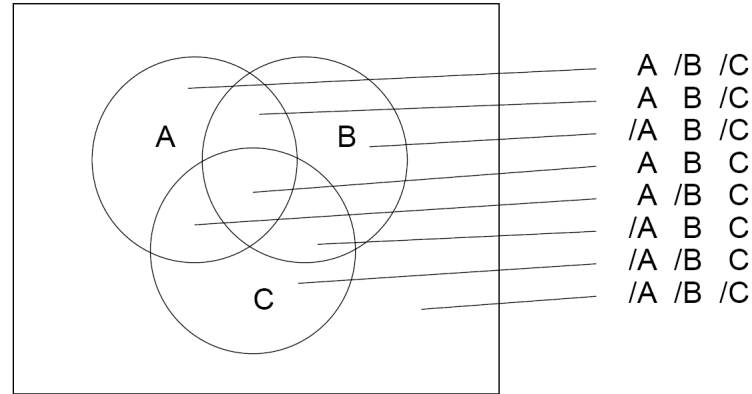

**Primer:** Z uporabo Vennovega diagrama minimiziraj logični izraz  $Y = \overline{A}\overline{B}C + \overline{A}BC + \overline{A}B\overline{C}$

A	B	C	Y
0	0	0	0
0	0	1	1
0	1	0	1
0	1	1	1
1	0	0	0
1	0	1	0
1	1	0	0
1	1	1	0

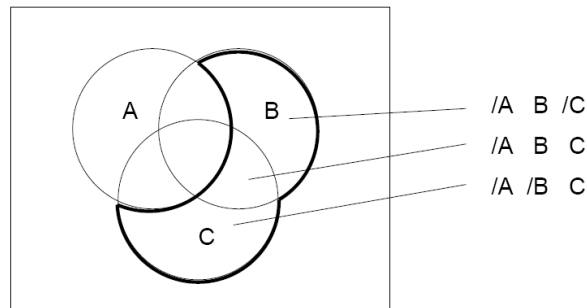

*Rezultat:*  $Y = \overline{A}\overline{B}C + \overline{A}BC + \overline{A}B\overline{C} = \overline{A} \cdot (B + C)$



# Minimizacija Boolovih funkcij

Veitchevi diagrami

$X_1$	$X_2$	$X_3$	Y
0	0	0	$m_0$
0	0	1	$m_1$
0	1	0	$m_2$
0	1	1	$m_3$
1	0	0	$m_4$
1	0	1	$m_5$
1	1	0	$m_6$
1	1	1	$m_7$

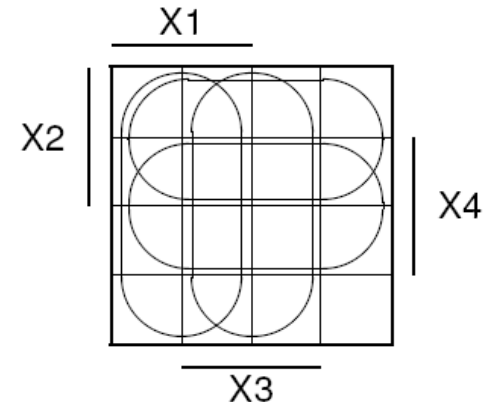
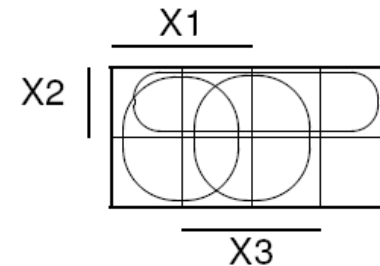
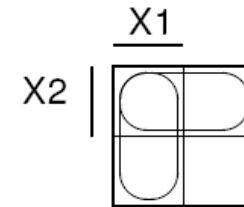
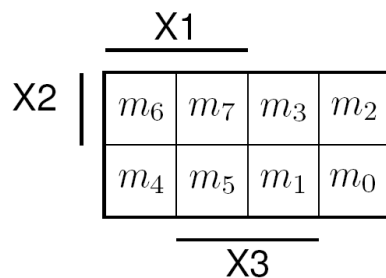

# Hazardna stanja pri kombinacijskih vezjih

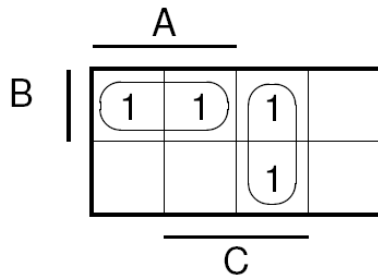

$$Y = AB + \bar{A}C$$

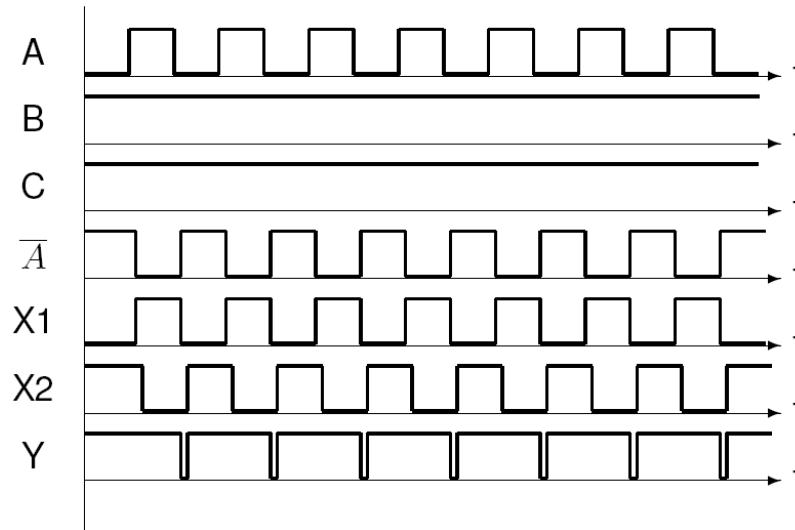
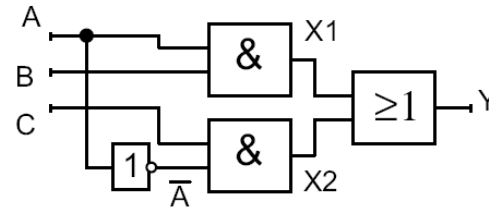

# Izvedba logičnih funkcij s programirljivimi kombinacijskimi vezji

PAL- programirljiva log. polja  
PLA- programirljive log. mreže  
Pomnilniki - EPROM

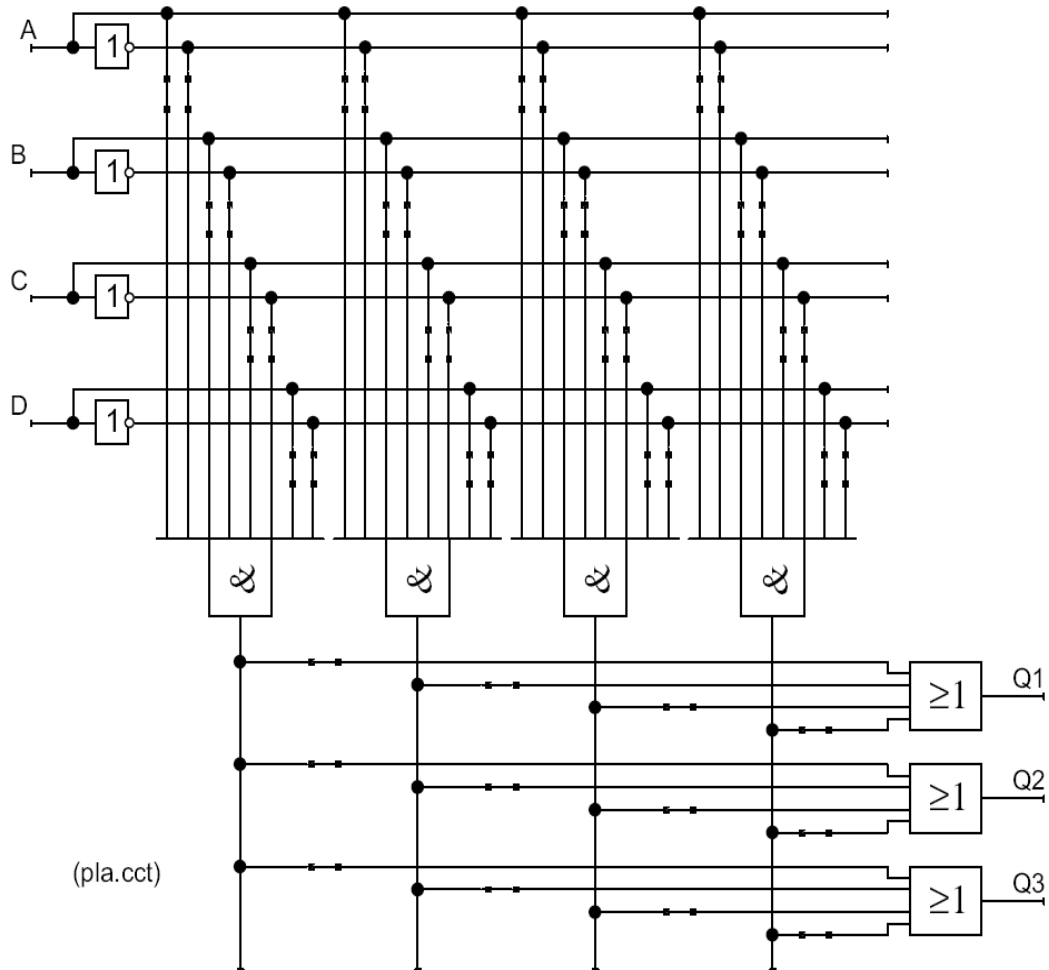



# FPGA vezja

<http://Iniv.fe.uni-lj.si/courses/iv/IV-uvod.pdf>

Field Programmable Gate Array = programirljiva matrika logičnih vrat

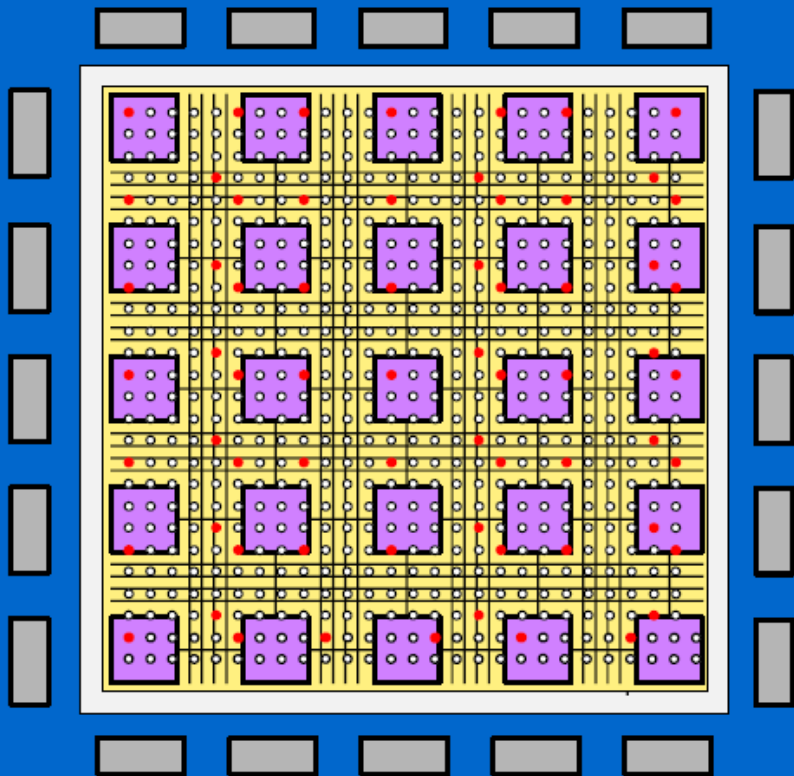



- Sestavljena so iz matrike logičnih blokov
- Povezovalno polje vsebuje veliko število povezav
- Konfiguracijski pomnilni elementi določajo povezave in vsebino logičnih blokov



# FPGA vezja

<http://lniv.fe.uni-lj.si/courses/iv/IV-uvod.pdf>

## Zgradba Xilinx FPGA vezij

-  CLB - konfiguracijski logični bloki
-  vhodno / izhodni bloki
-  povezovalno polje

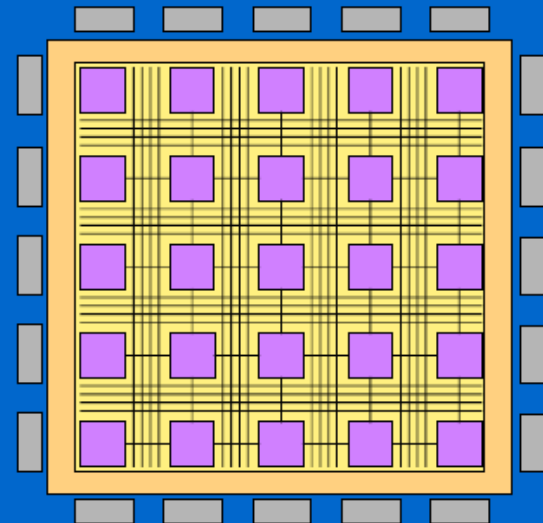

Npr. FPGA vezje Spartan XCS40 vsebuje:



- matriko 28 x 28 CLB-jev
- 224 vhodno / izhodnih blokov



# FPGA vezja

<http://lniv.fe.uni-lj.si/courses/iv/IV-uvod.pdf>

